

raquel cruz barbosa

faculdade de arquitetura - ulisboa

modelação e visualização tridimensional em arquitetura
docente eugénio coimbra | 2020/2021 | 2º semestre
miarq 3ºD | 20181250

SUMÁRIO AULA 4 (16 de março)

- _Continuação do estudo e resolução de exercícios em Autocad;
- _Elaboração do exercício Dado: Cubo Modelado com Esferas.dwg.
- _Elaboração do exercício Secção em Cones.dwg.
- _Elaboração do exercício Cubo Hiperbólico.dwg.
- _Elaboração do exercício Rampa.dwg.

(EXERCÍCIOS)

DADO: CUBO MODELADO COM ESFERAS

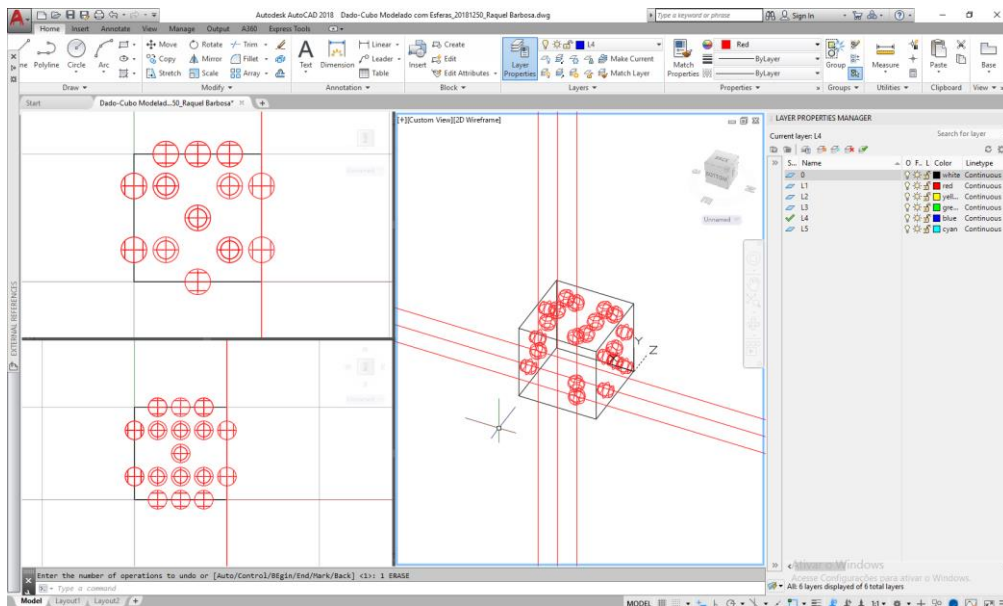

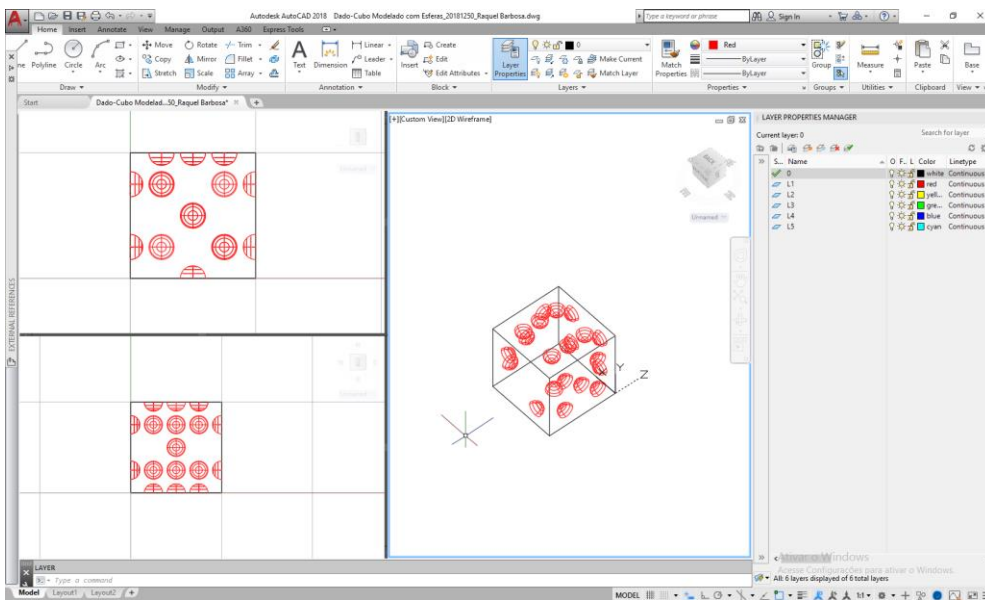
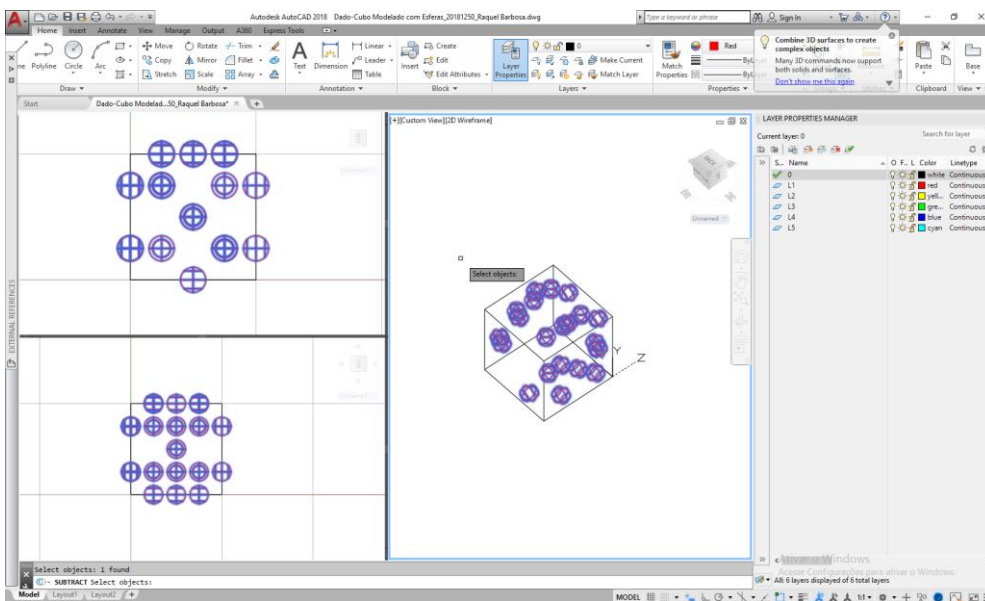
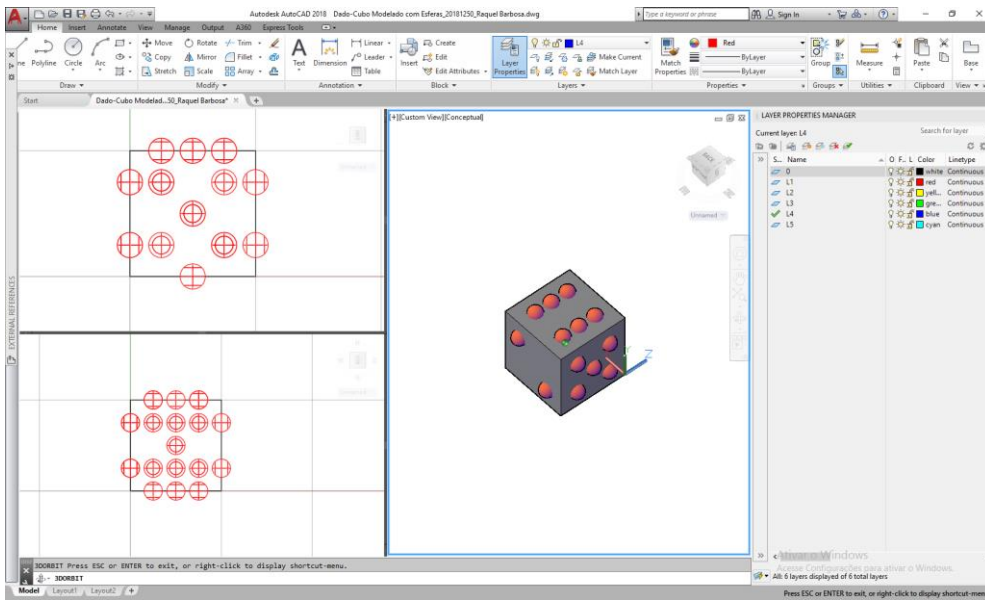

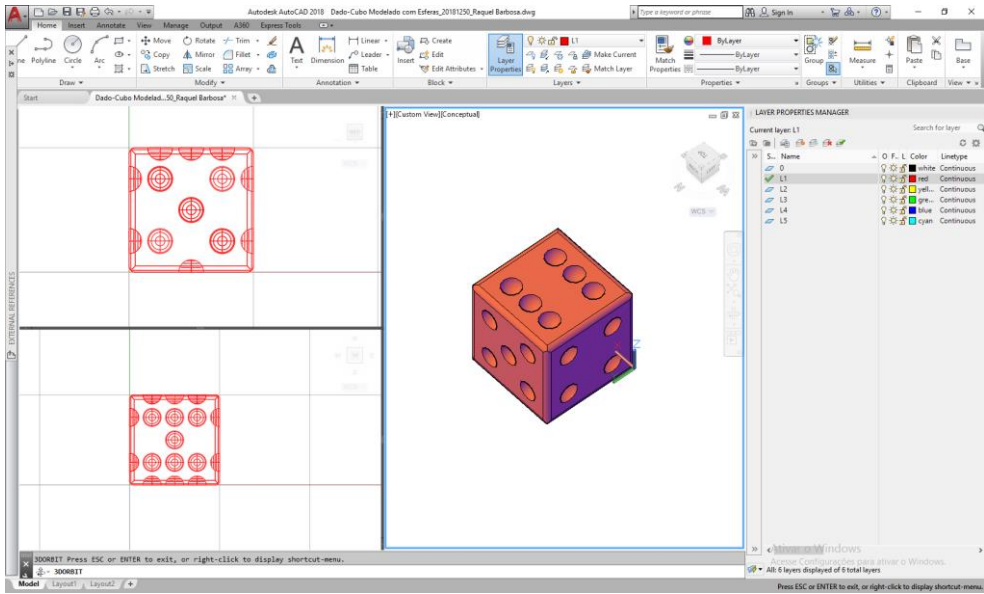

SECÇÃO EM CONES

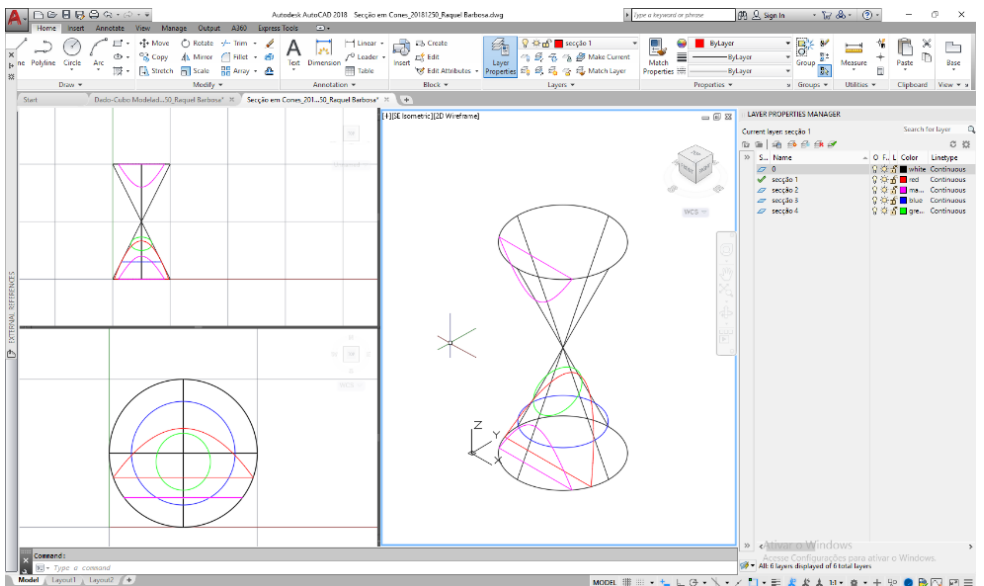
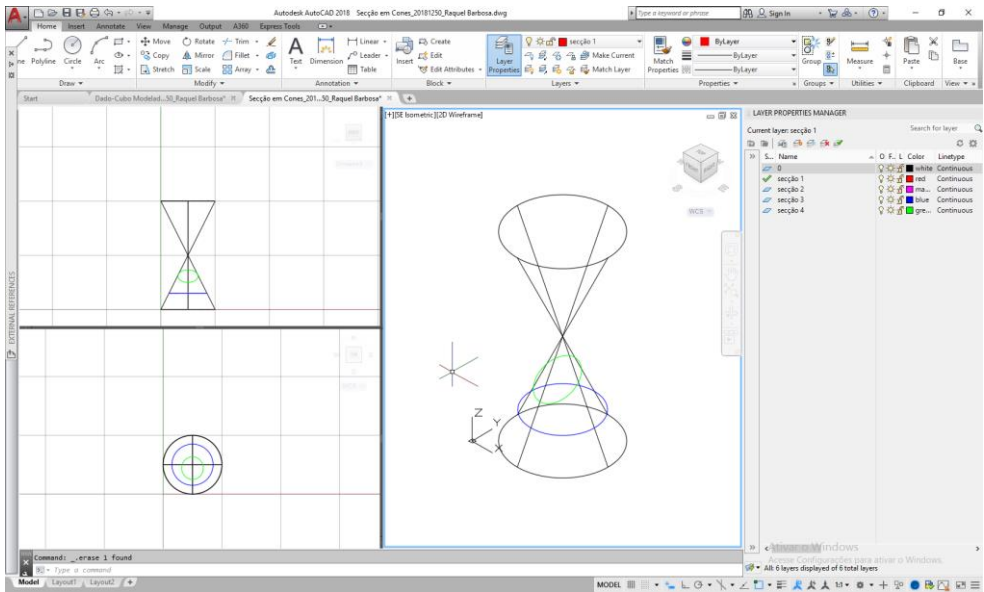

CUBO HIPERBÓLICO

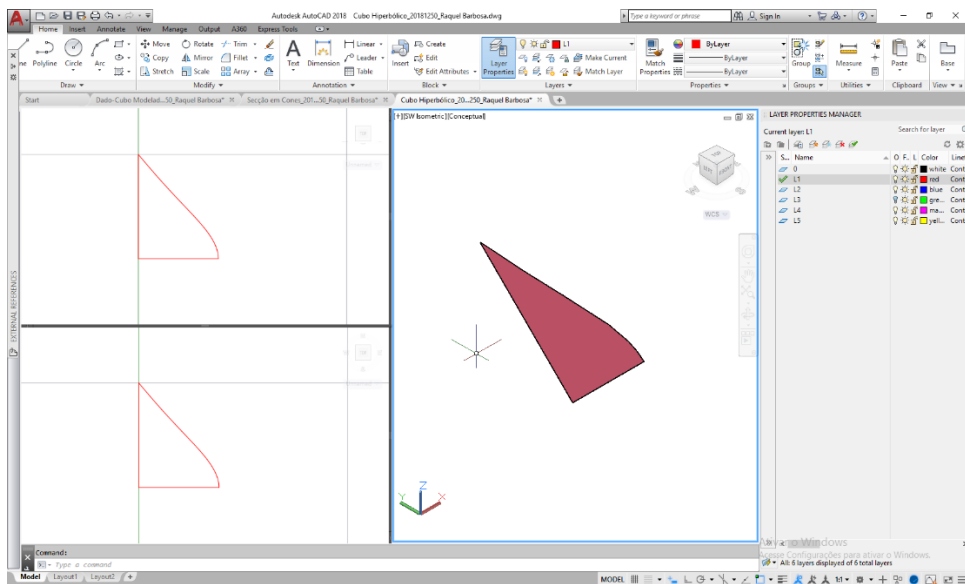
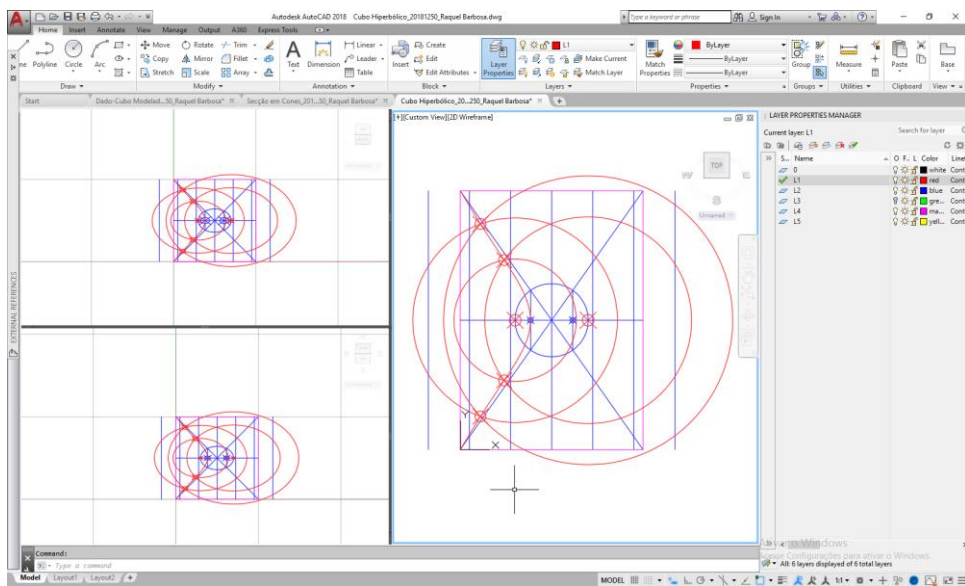
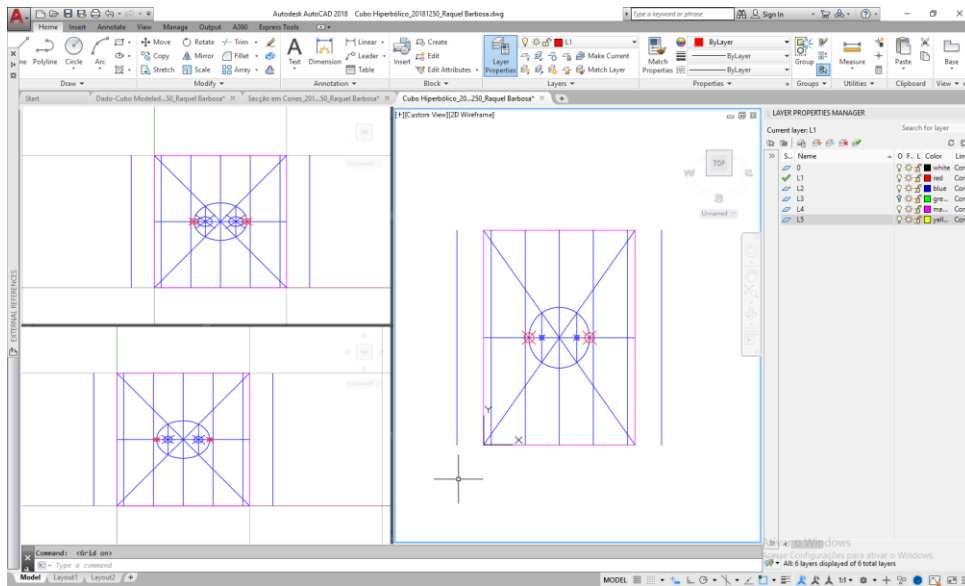

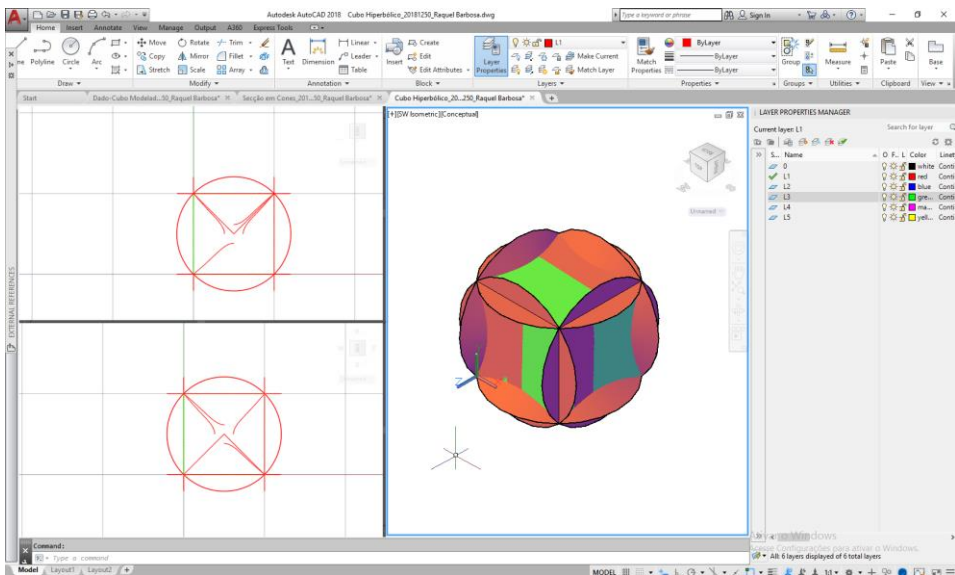
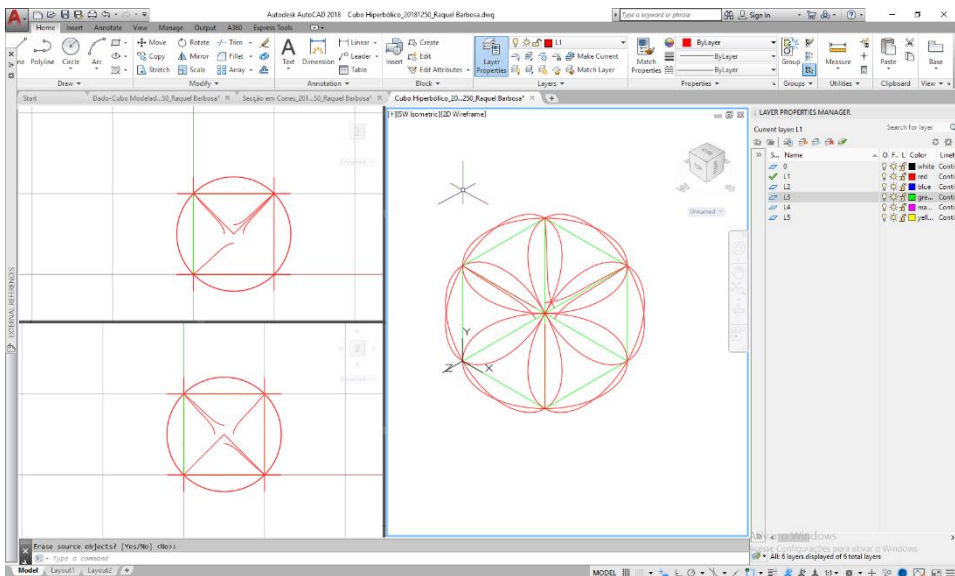
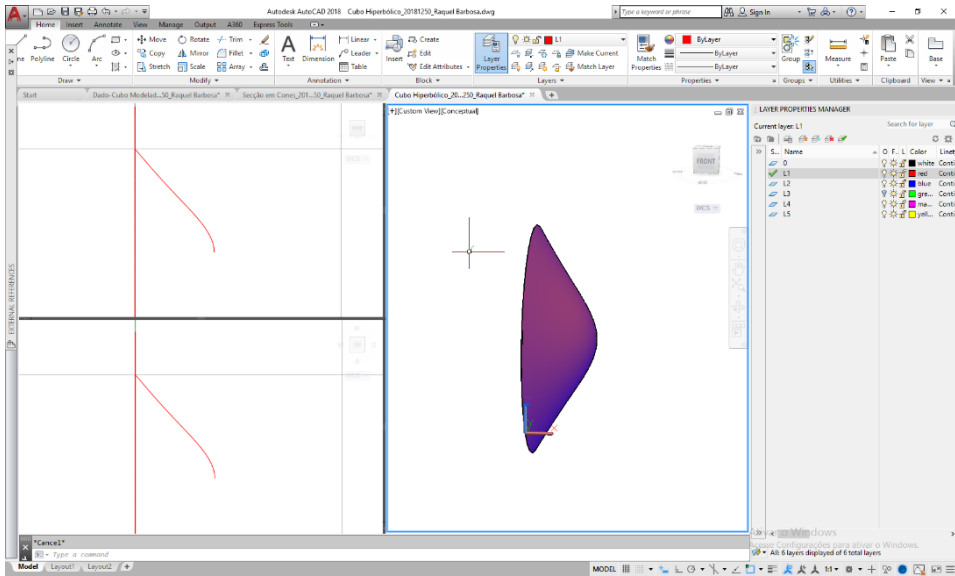

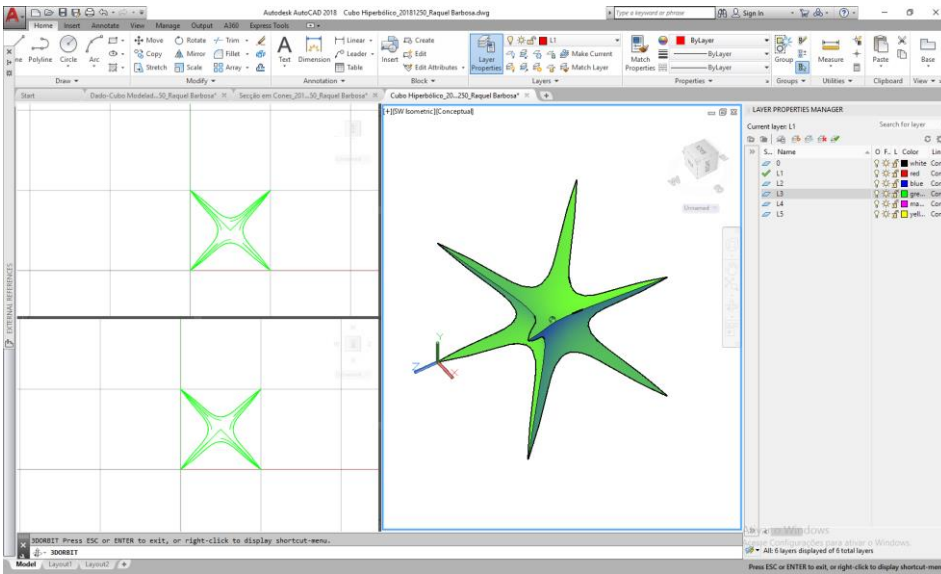
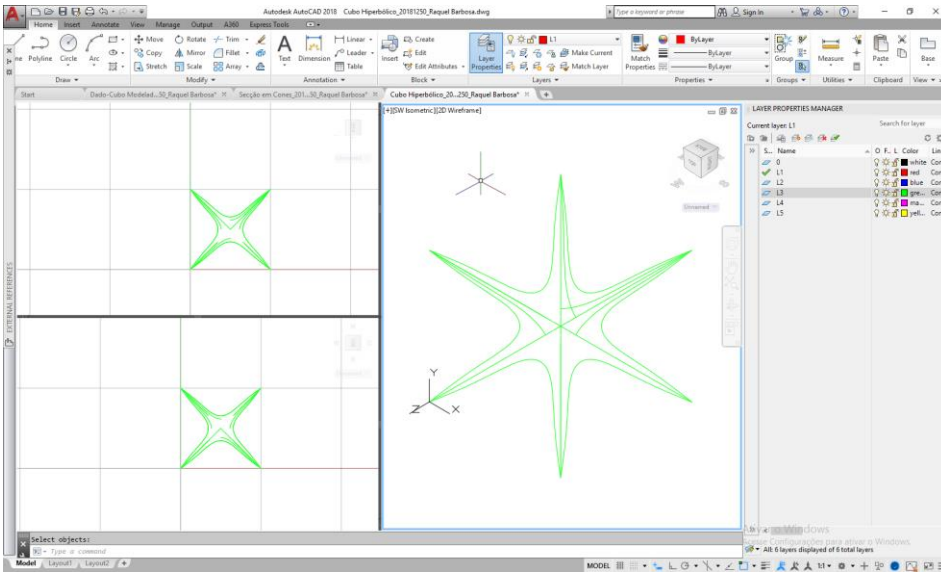

RAMPA

